

The Internet

Internet Technologies and Applications

Aim and Contents

- Aim:
 - Review the main concepts and technologies used in the Internet
 - Describe the real structure of the Internet today
- Contents:
 - Internetworking and internets
 - Internet Protocol (IP)
 - The Internet

Internetworking

- Each access/core network may use different network technologies
 - Depending on the requirements of users and operators
- We want any user to be able to communicate with any other user, independent of network technology
 - Use a common network protocol (IP) and routers to connect the networks

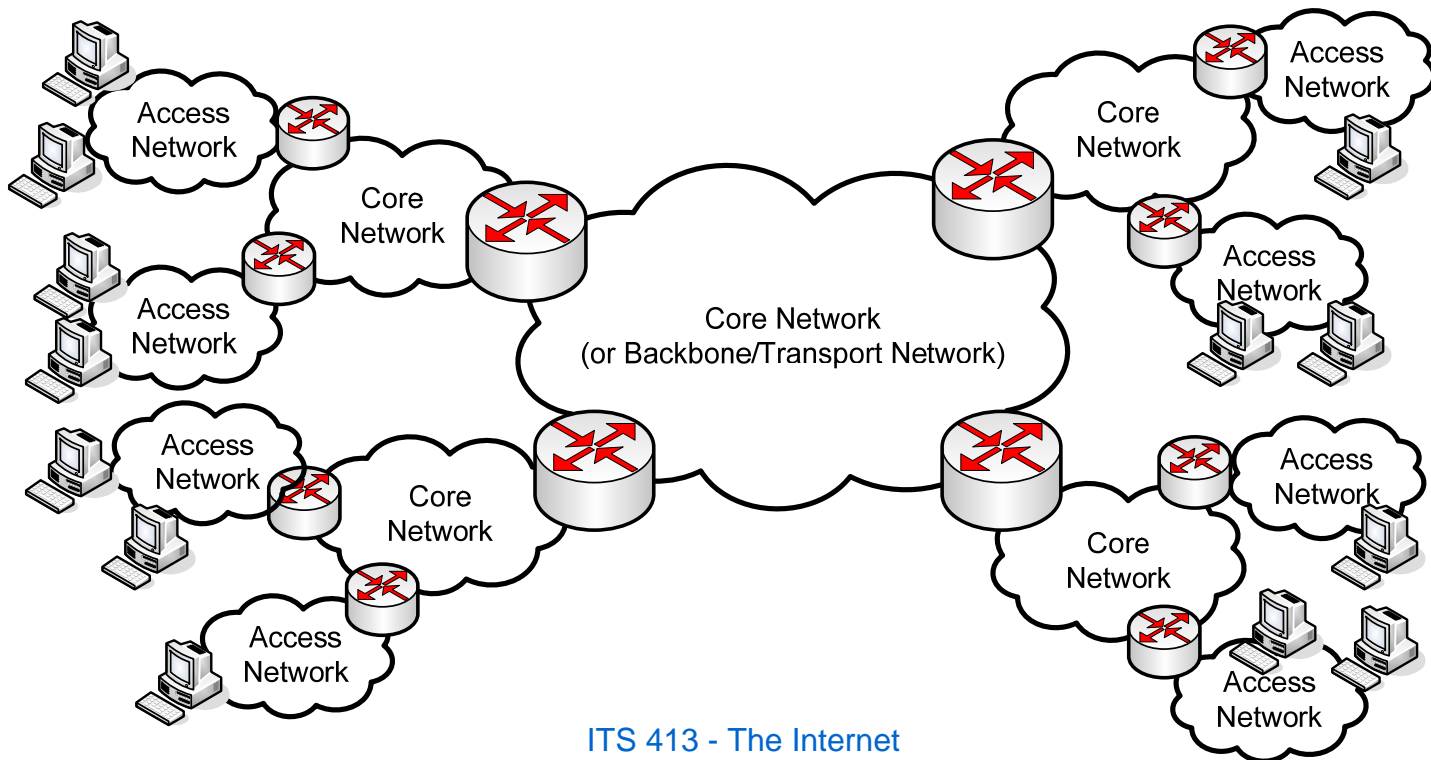

Internet Protocol

- Features of IP
 - Connection-less, network layer, datagram packet switching system
 - IP datagrams: delivery from source to destination
 - No guarantees! (datagrams may be lost, arrive out-of-order, arrive in error)
 - Multiplexing
 - Protocol numbers are used to identify the type of data (e.g. TCP or UDP)
 - IP addressing
 - Fragmentation and Re-assembly
- IP is designed to support many different types of transport protocols, and operate over many different types of data link protocols

IP in Internet 5 Layer Model

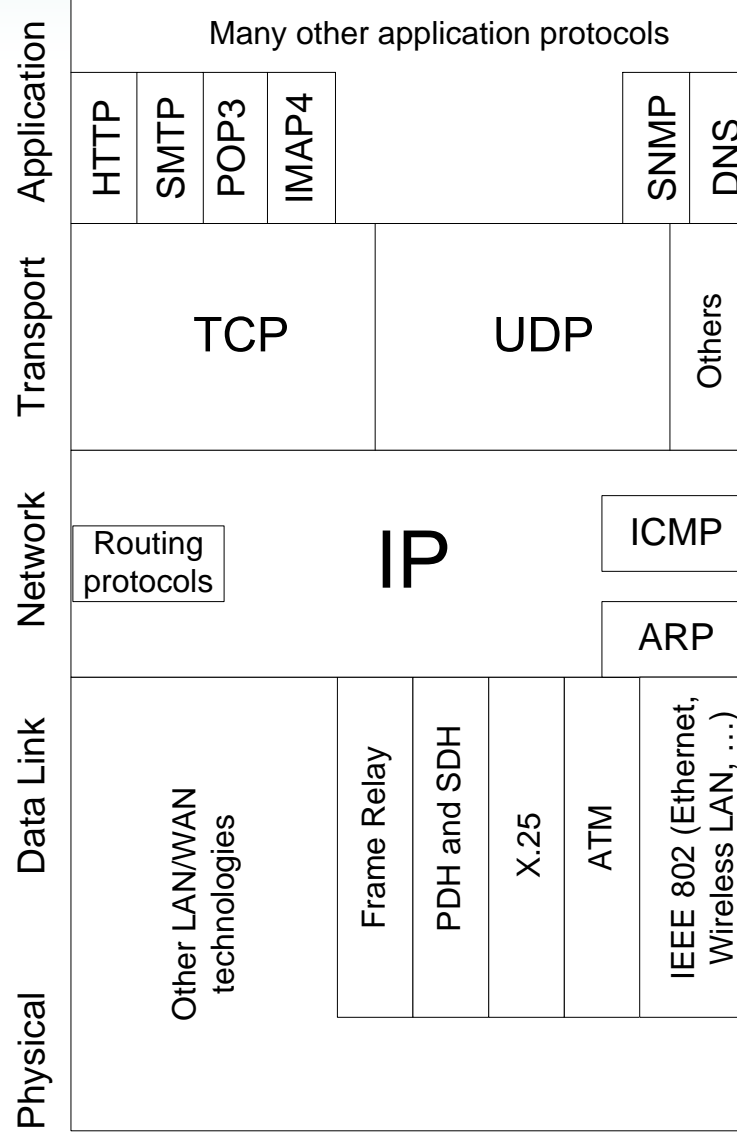

IP Hosts and Routers

- **Hosts** are the end-devices (stations)
 - Assume hosts have single interface (only attached to one LAN/WAN)
 - In practice, hosts can have multiple interfaces
 - Hosts do not forward datagrams
 - A host is either source or destination; if a host receives a datagram and the host is not the destination, then the host will discard the datagram
- **Routers** are the datagram packet switches
 - Routers have two or more interfaces (since they connect LANs/WANs together)
 - Routers forward datagrams
 - Routers can act as a source or destination of datagrams (however this is mainly for management purposes)
- **IP routing** is the process of discovering the best path between source and destination
 - Adaptive routing protocols execute on routers/hosts to find the path; the paths are stored in routing tables on routers and hosts
- **IP forwarding** is the process of delivering an IP datagram from source to destination

IP Hosts and Routers

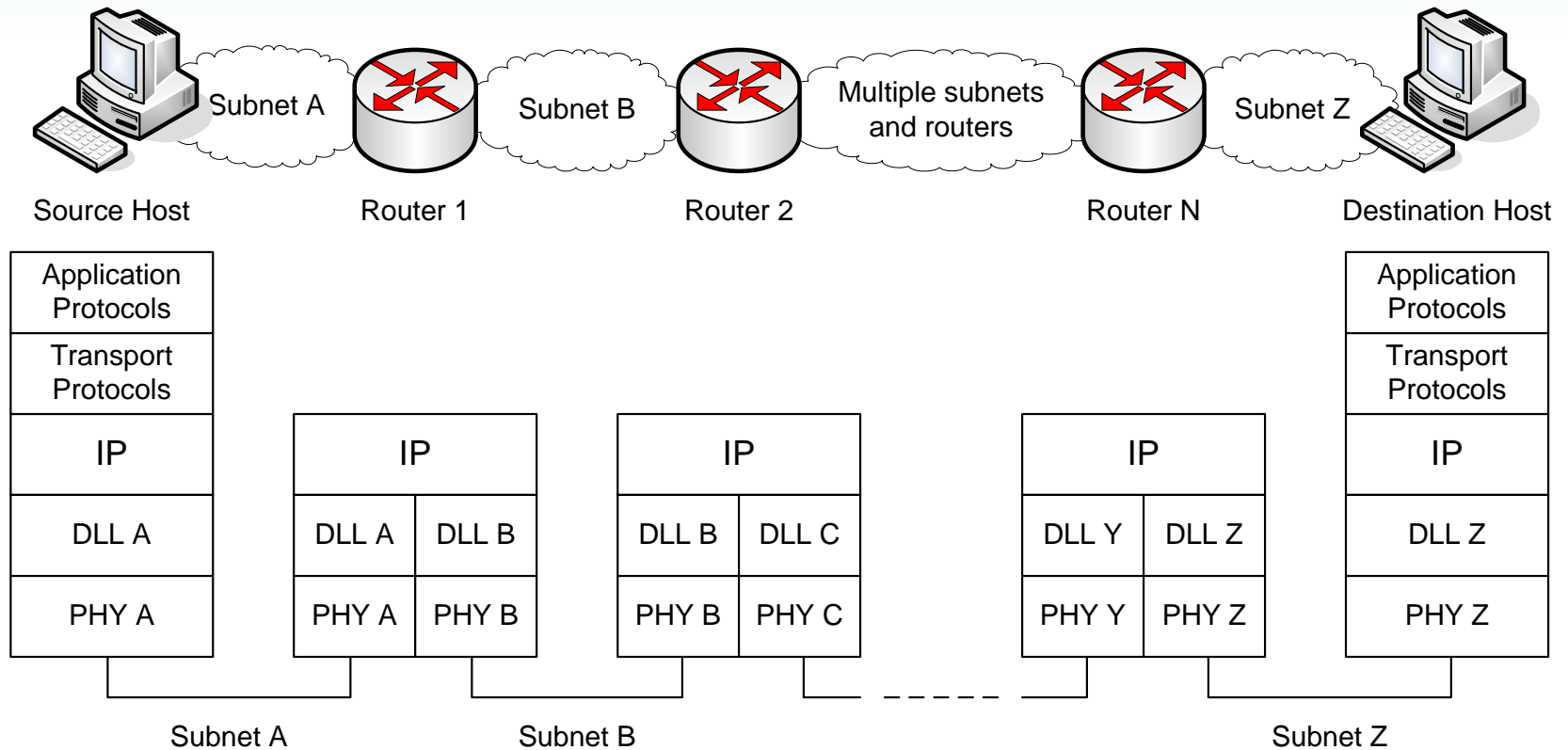

- IP is implemented at Layer 3 (Networking layer) in Hosts and Routers
 - Typically as software in a host or router operating system
- There may be 0 or more Routers between a source Host and destination Host

IP Datagram

- IP datagram consists of a variable length header and variable length of data
 - Header has 20 bytes for required fields; then optional fields bringing maximum size to 60 bytes
 - Data length is variable (but must be integer multiple of 8 bits in length); maximum size of datagram (that is, header + data) is 65,535 bytes

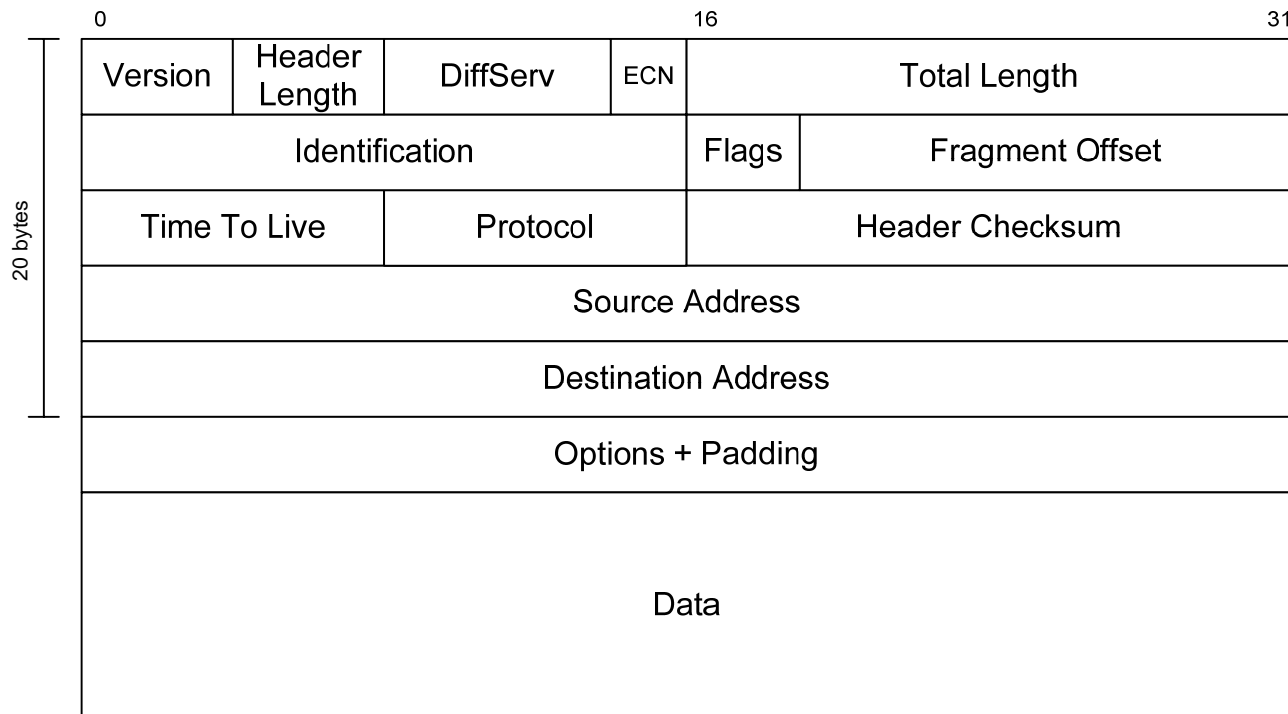

IP Datagram Fields

- **Version** [4 bits]: version number of IP; current value is 4 (IPv4)
- **Header Length** [4 bits]: length of header, measured in 4 byte words; minimum value is 5 (20 bytes); maximum is 15 (60 bytes)
- **DiffServ** [6 bits]: Used for quality of service control. DiffServ and ECN used to be called Type of Service field.
- **ECN** [2 bits]: Used for notifying nodes about congestion
- **Total Length** [16 bits]: total length of the datagram, including header, measured in bytes. Max 65535 bytes in datagram
- **Identification**: sequence number for datagram
- **Flags**: 2 bits are used for Fragmentation and Re-assembly, the third bit is not used
 - Don't Fragment bit: if set to 1, then the datagram will not be fragmented (it will be discarded if fragmentation is needed)
 - More Fragments bit: if datagram is fragmented, then set to 1 on all fragments except the last fragment
- **Fragment Offset** [13 bits]: Indicates where this fragment belongs in the original datagram, measured in blocks of 8 bytes
- **Time To Live** [8 bits]: how long datagram should remain in internet. In practice used as a hop counter (a router decrements every time it is forwarded)
- **Protocol** [8 bits]: indicates the next higher layer protocol with a code (e.g. TCP = 6; UDP = 17; ICMP = 1)
- **Header Checksum** [16 bits]: error-detecting code applied to header only (to check for errors in the header); recomputed at each router
- **Source Address** [32 bits]: IP address of source host
- **Destination Address** [32 bits]: IP address of destination host
- **Options**: variable length fields to include options
- **Padding**: used to ensure datagram is multiple of 4 bytes in length
- **Data**: variable length of the data

IP Addressing (Classless)

- 32 bit IP address is divided into two parts:
 - Network portion: identifies the IP network (or subnet) within an internet
 - Host portion: identifies a host within the IP network
- An **address mask** or **subnet mask** identifies where the split is:
 - The mask is 32 bits: a bit 1 indicates the corresponding bit in the IP address is the network portion; a bit 0 indicates the corresponding bit in the IP address is the host portion

IP address, 130.17.41.129:	10000010 00010001 00101001 10000001
Subnet mask, 255.255.252.0:	11111111 11111111 11111100 00000000
	Network portion Host portion
Network, 130.17.40.0:	10000010 00010001 00101000 00000000

- The mask can be given in dotted decimal form or a shortened form, which counts the number of 1 bits
 - The above example can be written as /22, and the IP address as 130.17.41.129/22

Special Cases for IP Addresses

- There are special case addresses that cannot be used to identify a particular host:
 - Network Address
 - The bits of the Host portion are 0
 - Used to identify the network, e.g. for routers to send to a network
 - E.g. host 130.17.41.129/22 is on the network 130.17.40.0/22
 - Broadcast Address (Directed)
 - The bits of the Host portion are 1
 - Used as a destination for broadcast directed to a specific network
 - E.g. host 130.17.41.129/22 sends to 116.42.2.255/24, then all hosts on network 116.42.2.0/24 will receive the datagram
 - Loopback Address
 - The first 8 bits of Network portion are 01111111 (decimal: 127)
 - Used as a destination address when a host sends to itself
 - E.g. host 130.17.41.129/22 sends to 127.0.0.1, then the datagram will not be sent on the network, but instead to itself (130.17.41.129)
 - Local Broadcast Address
 - All 32 bits are 1 (255.255.255.255)
 - Used as a destination for broadcast to the local network
 - E.g. host 130.17.41.129/22 sends to 255.255.255.255, then all hosts on network 130.17.40.0/22 will receive the datagram
 - Startup Source Address
 - All 32 bits are 0 (0.0.0.0)
 - Used as a source address by a host if the host doesn't know its own IP address
 - E.g. host sends an address to a known server (or local broadcast address) asking for its own IP address; 0.0.0.0 is used as the source

IP Routing

- IP does not include a routing protocol; any routing protocol may be used in an IP network
- Example: Link State Routing
 - Each router records the state of its own links: who do they link to and what does the link cost?
 - Each router sends a Link State Packet to all other routers in the network (using flooding)
 - Repeated when the link state changes
 - For all Link State Packets received, each router finds the least cost path from itself to every other node
 - Dijkstra's algorithm
 - Each router builds its routing table
 - Routing table: "in order to reach destination X, send to next node Y"
- IP uses the routing table to determine where to forward IP datagrams

The Internet Structure Today

Autonomous System (AS)

- Not practical to have *all* routers in the Internet participate in routing protocols
 - With large number of routers, overhead from routing protocols becomes too large
 - Routers owned by different organisations, that may use different, incompatible policies
- Routers are divided into groups based on the owner of a network
 - A group of networks and routers controlled by a single administrative authority is called an *autonomous system* (AS)
 - Although there are some large companies with AS, most AS correspond to Internet Service Providers (ISPs)
 - Each AS has an AS Number assigned by IANA (or the regional internet registry, such as APNIC)

AS Examples

- AS4637: Reach
- AS38040: TOT Internet Gateway
- AS2516: KDDI (Japan)

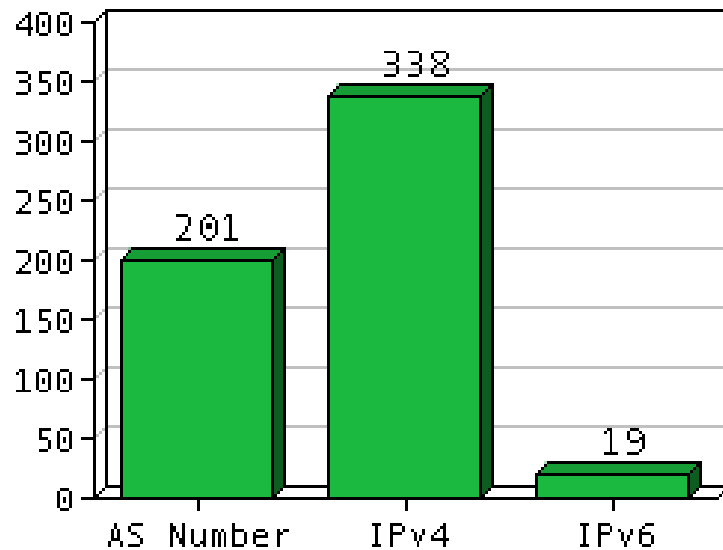

Allocated addresses in Thailand, 1 Oct 2008

Source: <http://internet.nectec.or.th/>

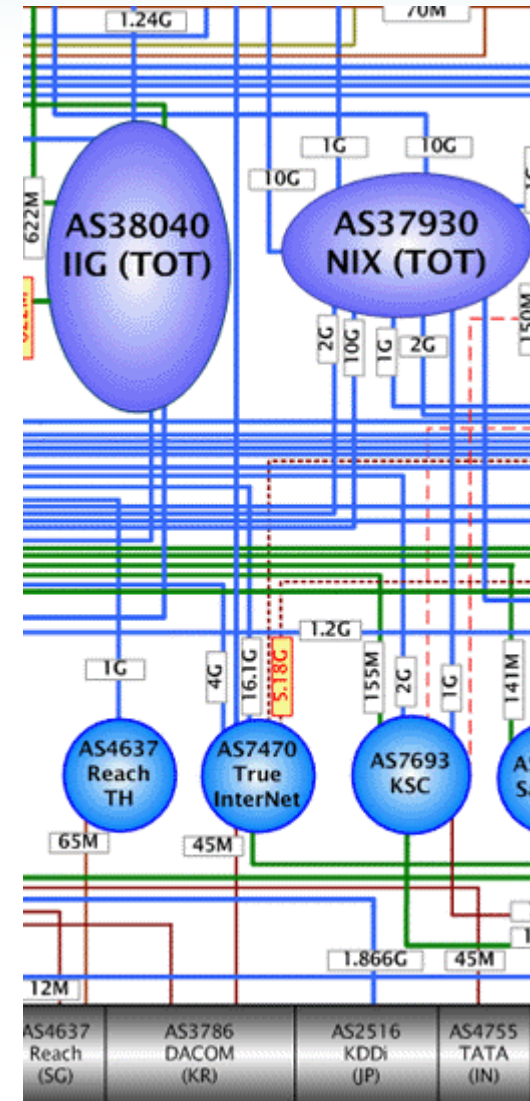

Thailand Internet Map, 13 Oct 2008

Source: <http://internet.nectec.or.th/>

Routing with Autonomous Systems

- Routing within an AS is performed using an Interior Gateway Protocol (IGP)
 - Gateway means the same as Router in this context
 - There are different IGPs available and in use; the owner of the AS may choose depending on their requirements
 - RIP, OSPF, IS-IS, IGRP, EIGRP, ...
- Routing between AS's is performed using an Exterior Gateway Protocol (EGP)
 - There is only one EGP used in the Internet: Border Gateway Protocol (BGP)
 - Neighbour AS's use BGP to advertise which networks are reachable via each other

Routers and Autonomous Systems

The Internet is made up by a collection of Autonomous Systems connected by Exterior (or Border) Routers

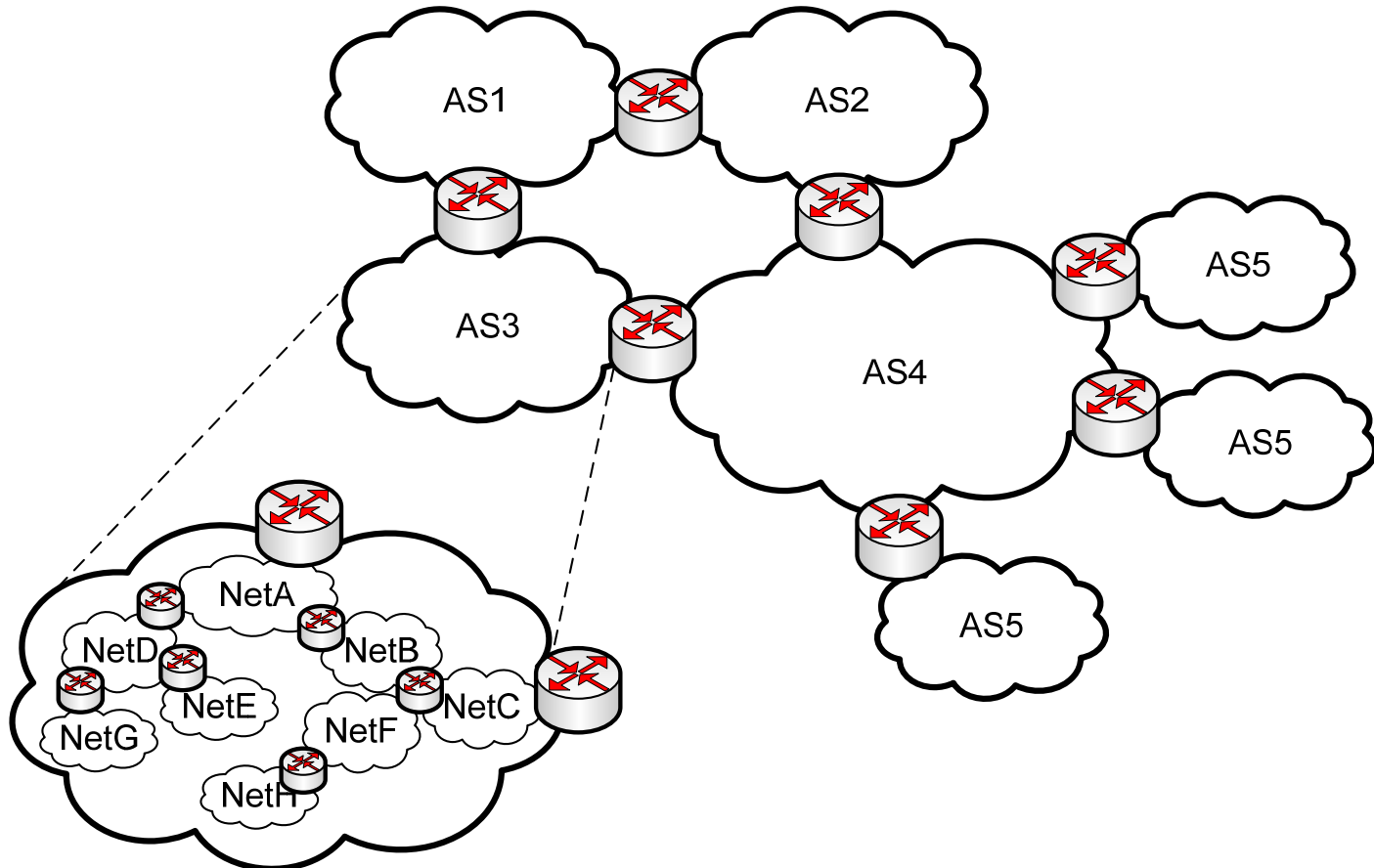

Autonomous System 3 may contain multiple IP networks (core or access) connected by Interior Routers

Connecting Between Autonomous Systems

- Two autonomous systems that connect together are known as *peers*
 - Usually (but not necessarily) an AS represents an ISP
- Connection between peers requires:
 - Physical Connection
 - Private peering
 - Two peers connect their border routers with a point-to-point connection such as SDH
 - Public peering
 - Multiple peers connect via shared network (e.g. Ethernet), usually at the one location called Internet Exchange Point (IXP or IX)
 - Agreement
 - Often a commercial contract is established, and technical/commercial/social policies agreed upon
 - Different types of agreements:
 - Transit: ISP1 pays ISP2 for traffic of ISP1 to access Internet via ISP2 (ISP2 is usually much larger than ISP1)
 - Peering: ISP1 and ISP2 exchange each others traffic freely

ISPs, Transit, Peering and Tiers

- Tier 1 ISPs do not have to pay for transit for any destination on the Internet
 - All Tier 1 ISPs peer with each other
 - Currently about 15 Tier 1 ISPs in the world, including:
 - AT&T, Qwest, NTT/Verio, Verizon, GlobalCrossing, ...
- Tier 2 ISPs are large ISPs that must pay for transit from some Tier 1 ISPs
 - Tier 2 ISPs often peer with other ISPs
 - Usually large regional or national ISPs
- Tier 3 ISPs usually pay for transit from Tier 2 (or 1) ISPs
- Customers (such as SIIT or you) pay for transit from one of the ISPs

- (Note the definition of tiers and peering differs across some sources; but the main concept of a hierarchy between ISPs, plus direct peering, applies)

Example of Transit and Peers

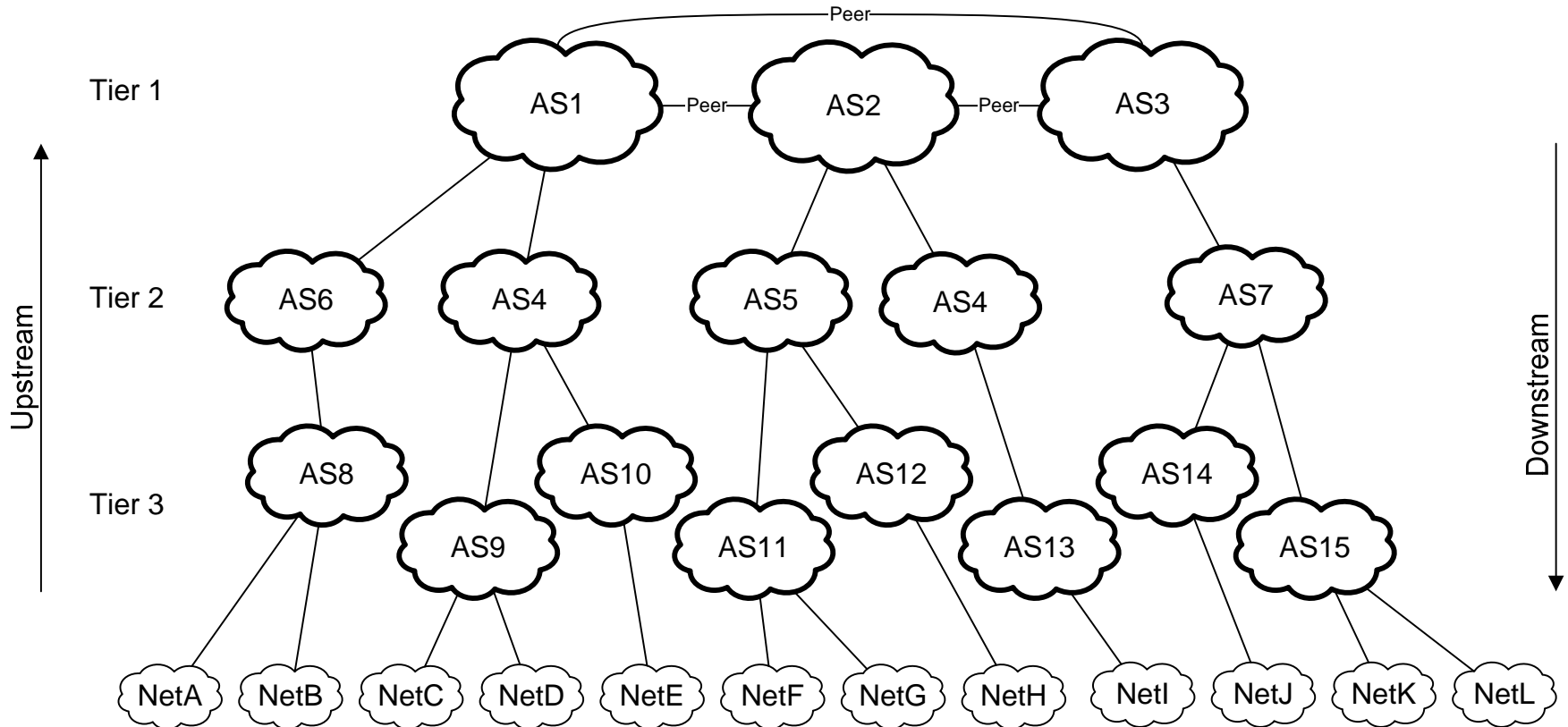

All links to a higher level AS (or ISP) are transit links: the customer pays for the traffic to transit the upstream ISPs network. All Tier 1 ISPs (AS) must peer with every other Tier 1 ISP

Example of Transit and Peers

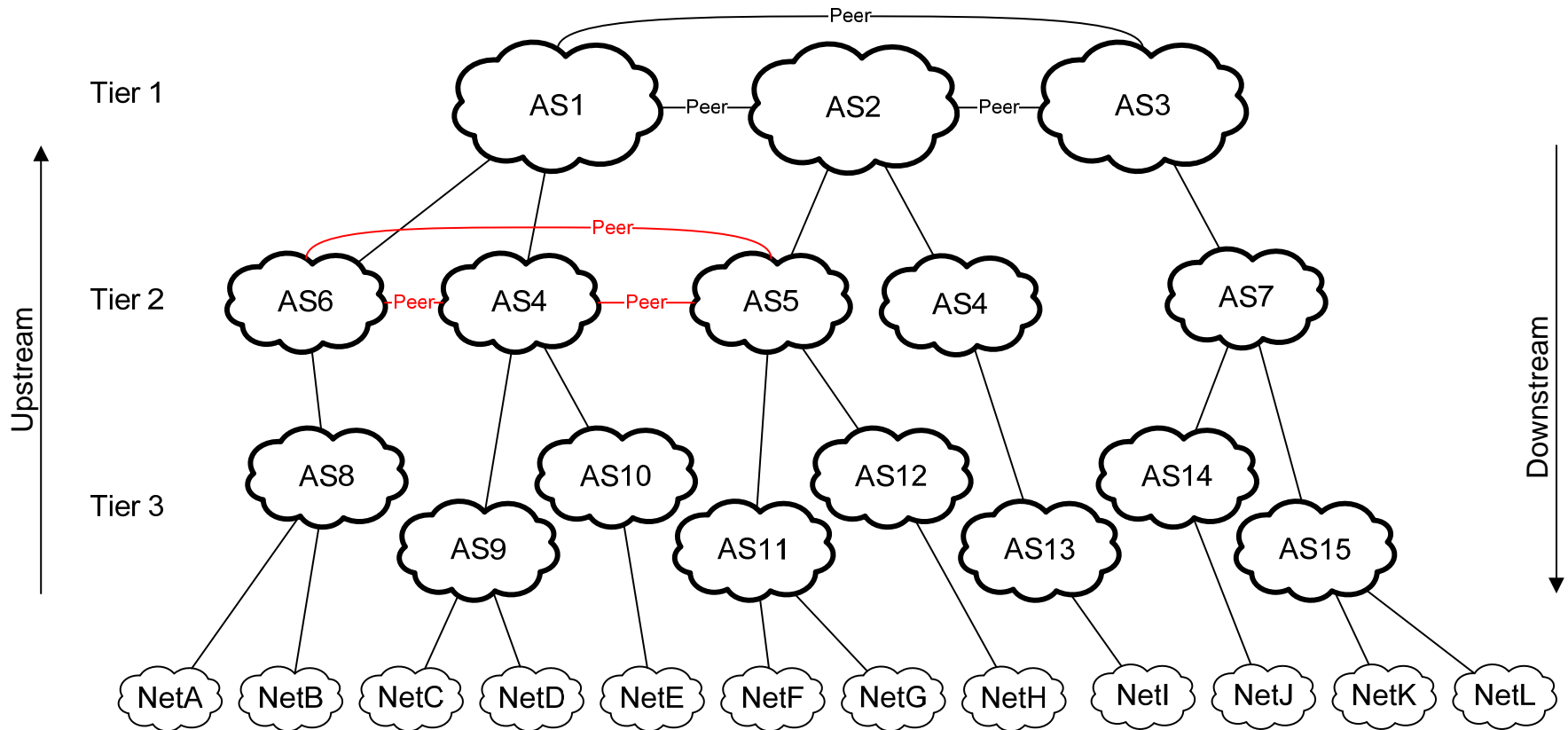

Here three ISPs have reached agreement so that traffic between their networks is exchanged for free, that is, *peering agreements*.

Internet Exchange Points

- Internet Exchange Points allow many ISPs to peer with each other
 - ISPs have connections into IXPs, and the IXP runs a switched network (often Ethernet) to connect all ISPs
 - IXPs are often large buildings or data centres; large IXPs support 100's of ISPs

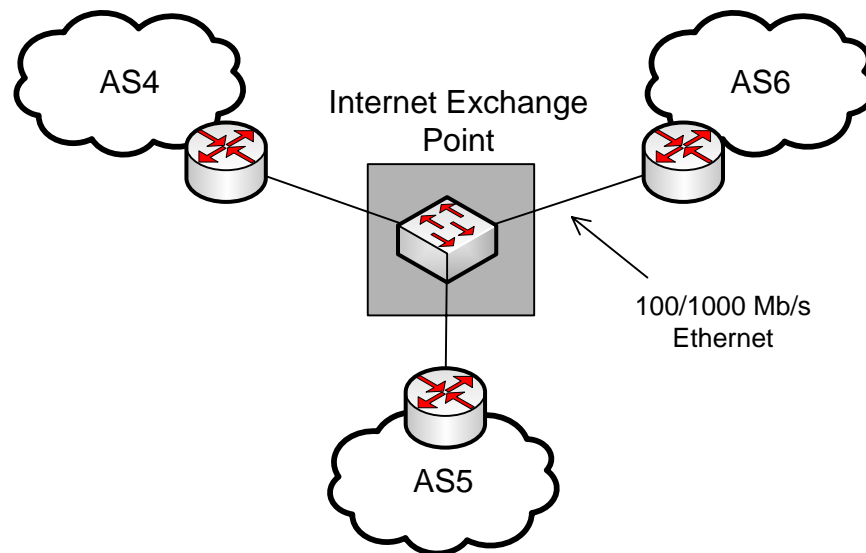

Content Providers

- Content Providers are a special case of network in the Internet
 - Example: Google/Youtube, Microsoft, Sony, Yahoo, ...
 - Most traffic is outbound/upstream (going from Content Provider to ISP and then to customer)
- Connect to Tier 1/2 ISPs: pay for transit
- Also creating peering arrangements
 - Example: Google have peering arrangements with multiple Tier2/3 ISPs
 - Google traffic (such as Youtube videos) sent over the peer ISPs network is free
 - Google does not have to pay a higher tier (such as Tier 1) for transit
 - Customers of the ISP get faster access to Google content
- Peering arrangements between ISPs and Content Providers benefits:
 - Lower transit costs for Content Providers
 - Better service from ISPs; more customers

Summary

- IP is used for internetworking the many different access/core networks together
 - Idea: Allow any IP device to communicate with any other IP device in an internet
- The Internet today has some hierarchical structure
 - Autonomous Systems (AS) typically correspond to Internet Service Providers (ISPs)
 - Within an AS, routing is performed using one of many interior gateway protocols
 - Between AS's, routing is performed using Border Gateway Protocol (BGP)
 - End-users (individuals, businesses) pay for transit via ISPs
 - ISPs pay for transit via other ISPs, and/or peer with ISPs