

Local Area Networks

ITS323: Introduction to Data Communications

Sirindhorn International Institute of Technology
Thammasat University

Prepared by Steven Gordon on 9 August 2011
ITS323Y11S1L11, Steve/Courses/ITS323/Lectures/lans.tex, r1910

Contents

LAN Design Elements

IEEE 802 LANs

IEEE 802.3 MAC Frames and Addresses

WANs and LANs

Wide Area Networks

- ▶ Connect devices/networks over large geographical area
- ▶ Between campuses, office buildings, cities, countries
- ▶ Owned and operated by organisations on behalf of users, e.g. TOT, CAT, TT&T
- ▶ Leased to users, e.g. unis, companies, smaller ISPs

Local Area Networks

- ▶ Connect end-user devices over small area
- ▶ Within campuses, buildings, homes
- ▶ Owned and operated by organisation using the network
- ▶ Typically support higher data rates than WANs (internal communications, multiplexing)

LAN Design Elements

- ▶ Topology: what is the arrangement of connections between nodes?
- ▶ Transmission medium: what medium is used for the links?
- ▶ Medium access control: how to control access for stations on a shared medium?

LAN Topology

- ▶ Recall link configurations: point-to-point and multipoint
- ▶ LANs allow multiple users to communicate with each other
- ▶ Topology is arrangement of nodes and links
 - Mesh** every station has point-to-point link to every other station
 - Bus** every station connected via a multipoint link
 - Ring** point-to-point links between pairs of stations to form ring
 - Star** every station has point-to-point link to central device
 - Hybrid** combination of 2 or more of above, e.g. tree is combination of star and bus topologies
- ▶ Mesh only suitable for very small LANs; requires many links. (Partial mesh used in some WANs)

Bus Topology

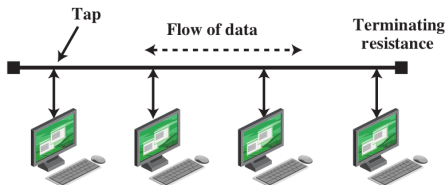

- ▶ Single multipoint link connects all stations (via tap)
- ▶ Transmission propagates throughout medium and is heard by all stations
- ▶ Terminator absorbs frames at end of medium/cable
- ▶ Frames need addresses
- ▶ Pros: easy installation
- ▶ Cons: require protocols to share medium; faulty link stops all communications; limited number of stations
- ▶ Usage: Early Ethernet networks, but replaced by star

Frame Transmission on a Bus LAN

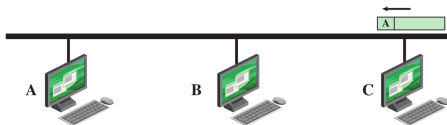

C transmits frame addressed to A

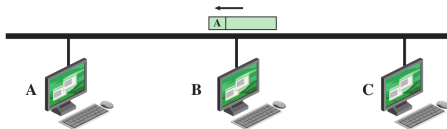

Frame is not addressed to B; B ignores it

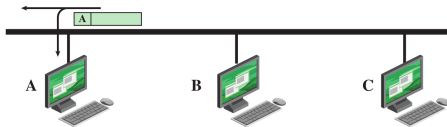

A copies frame as it goes by

Ring Topology

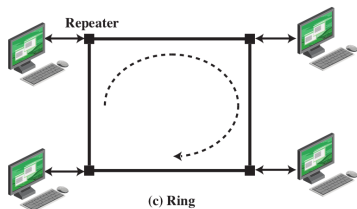

- ▶ Unidirectional point-to-point links to form loop
- ▶ Stations attach to repeaters
- ▶ Frames need addresses
- ▶ Pros: simple to install and reconfigure; easy to identify faults
- ▶ Cons: require protocols to share medium; traffic flows in one direction
- ▶ Usage: old LANs (e.g. IBM Token Ring); MANs and WANs

Frame Transmission on a Ring LAN

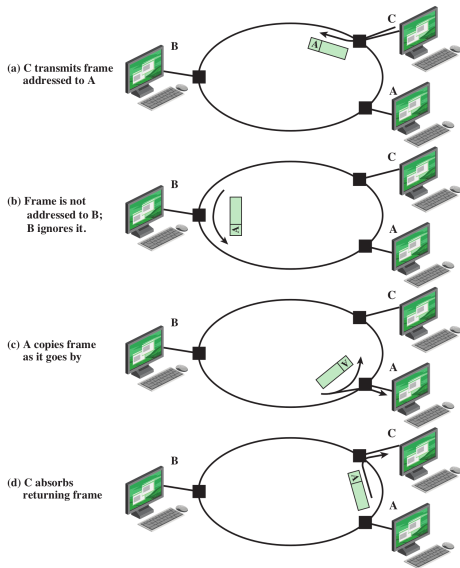

Star Topology

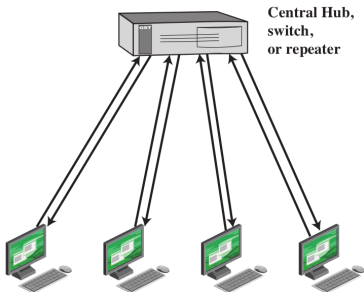

- ▶ Traffic between stations goes via the central node
- ▶ Usually two point-to-point links between station and central node (or duplex link)
- ▶ Frames needed addresses
- ▶ Pros: easy to install; fault tolerance for links
- ▶ Cons: depends on central node
- ▶ Usage: Most LANs today

Transmission Medium

- ▶ Many factors impact on the most appropriate transmission medium for a LAN: reliability, expandability, performance, building layout, medium availability
- ▶ Common cases include:
 - ▶ Coaxial cable often used for bus topology
 - ▶ Optical fibre for ring topology; usually the highest speed networks
 - ▶ Twisted pair for star topologies; often well-suited for LANs in buildings (cheap, easy to install)

Medium Access Control

- ▶ In a shared medium, if two (or more) stations transmit at the same time, there is a chance the two transmissions will interfere with each other
- ▶ **Collision** of frames: receiver receives two or more frames partially overlapping in time; assume all frames are corrupted/lost
- ▶ **Medium Access Control**: allow one station to use the shared medium at a time (avoiding collisions)
- ▶ MAC techniques must give stations opportunities to transmit: fair and efficient
- ▶ Techniques can be:
 - ▶ Centralised or distributed
 - ▶ Fixed or dynamic

MAC Examples

- ▶ Round-Robin MAC
- ▶ Reservation-based MAC
- ▶ Random-access MAC

Contents

LAN Design Elements

IEEE 802 LANs

IEEE 802.3 MAC Frames and Addresses

IEEE 802 LAN Architecture

- ▶ IEEE 802 LAN/MAN standards committee has developed the majority of the LAN standards in use including:
 - ▶ Ethernet, Fast Ethernet, Gigabit Ethernet, Token Ring, Wireless LAN (WiFi), ...
- ▶ 802 series of standards follow common architecture
- ▶ Standardised only at Physical layer and Data Link layer
- ▶ Data Link layer divided into: Logical Link Control (LLC) and Medium Access Control (MAC)
- ▶ 802 can support many MAC/Physical protocols, and uses one common LLC protocol

IEEE 802 LAN Architecture

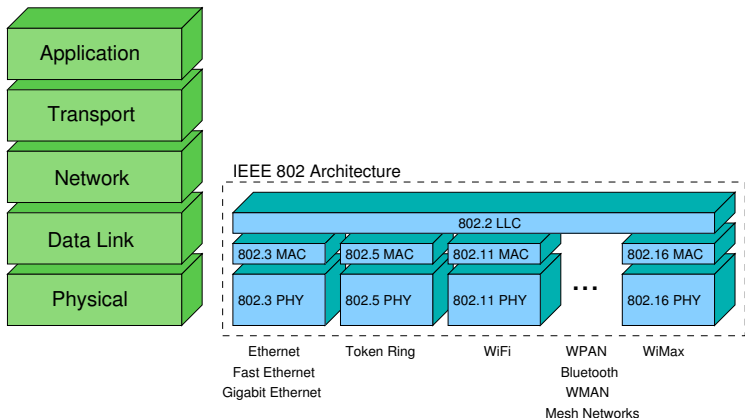

LLC = Logical Link Control

MAC = Medium Access Control

PHY = Physical

Characteristics of Some High-Speed LANs

	Fast Ethernet	Gigabit Ethernet	Fibre Channel	Wireless LAN
Data Rate	100 Mbps	1 Gbps, 10 Gbps, 100 Gbps	100 Mbps - 3.2 Gbps	1 Mbps - 54 Mbps
Transmission Media	UTP, STP, optical fiber	UTP, shielded cable, optical fiber	Optical fiber, coaxial cable, STP	2.4-GHz, 5-GHz microwave
Access Method	CSMA/CD	Switched	Switched	CSMA/Polling
Supporting Standard	IEEE 802.3	IEEE 802.3	Fibre Channel Association	IEEE 802.11

IEEE 802.3: Ethernet

- ▶ IEEE 802.3 defines one of the most commonly used LAN standards in the world
- ▶ Ethernet developed in 1970's; standardised as IEEE 802.3
- ▶ Various improvements: Fast Ethernet, Gigabit Ethernet, 10Gb/s Ethernet
- ▶ Support various physical media: UTP, STP, coaxial cable, optical fibre
- ▶ Original popular Ethernet:
 - ▶ Bus topology
 - ▶ Coaxial cable
 - ▶ 10Mb/s
 - ▶ Contention-based Random-Access MAC (CSMA/CD)
 - ▶ Half-duplex
- ▶ Replaced by star topology with twisted pair

IEEE 802.3 10-Mbps Physical Layer Medium Alternatives

	10BASE5	10BASE2	10BASE-T	10BASE-FP
Transmission medium	Coaxial cable (50 ohm)	Coaxial cable (50 ohm)	Unshielded twisted pair	850-nm optical fiber pair
Signaling technique	Baseband (Manchester)	Baseband (Manchester)	Baseband (Manchester)	Manchester/on-off
Topology	Bus	Bus	Star	Star
Maximum segment length (m)	500	185	100	500
Nodes per segment	100	30	—	33
Cable diameter (mm)	10	5	0.4 to 0.6	62.5/125 μm

Shared Medium Bus

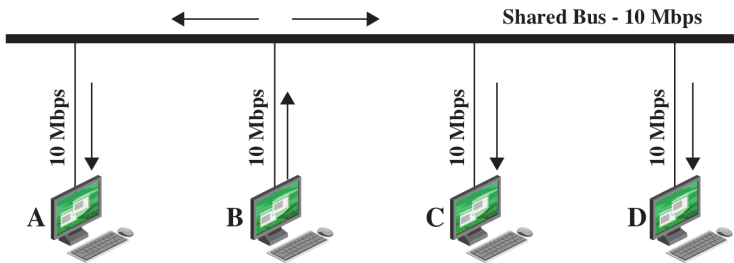

Shared Medium Hub

Hub: receives a frame on an input link, and transmits a copy of that frame on all other output links

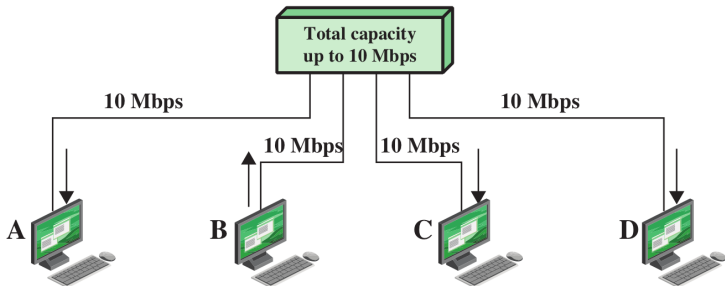

Layer 2 Switch

Switch: receives a frame on an input link, looks at the destination address, and transmits the frame on the intended output link

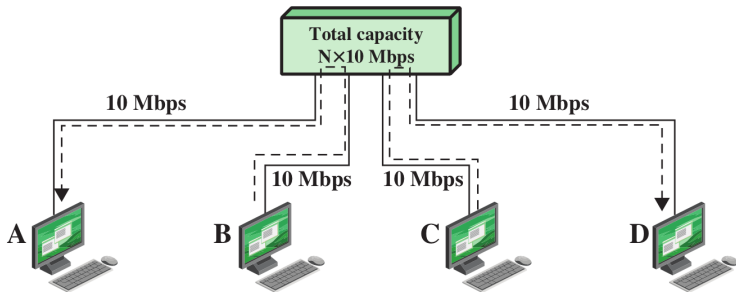

IEEE 802.3 100BASE-T Physical Layer Medium Alternatives

	100BASE-TX		100BASE-FX	100BASE-T4
Transmission medium	2 pair, STP	2 pair, Category 5 UTP	2 optical fibers	4 pair, Category 3, 4, or 5 UTP
Signaling technique	MLT-3	MLT-3	4B5B, NRZI	8B6T, NRZ
Data rate	100 Mbps	100 Mbps	100 Mbps	100 Mbps
Maximum segment length	100 m	100 m	100 m	100 m
Network span	200 m	200 m	400 m	200 m

Gigabit Ethernet Medium Options (log scale)

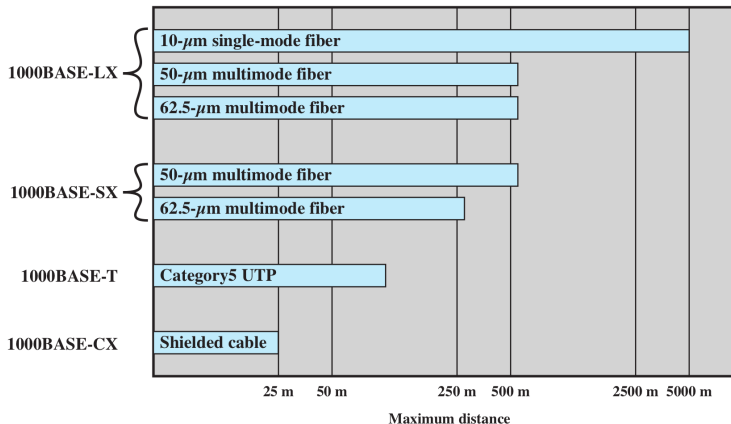

Example LAN Configuration

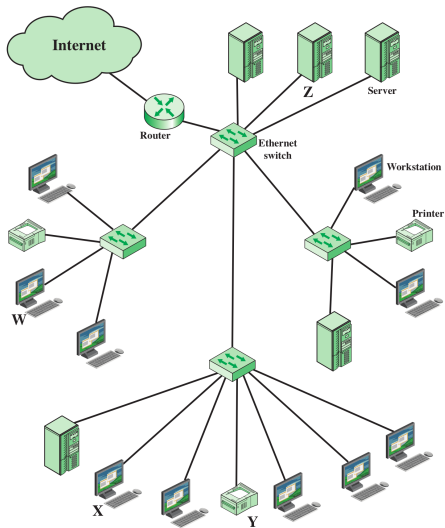

Example Gigabit Ethernet Configuration

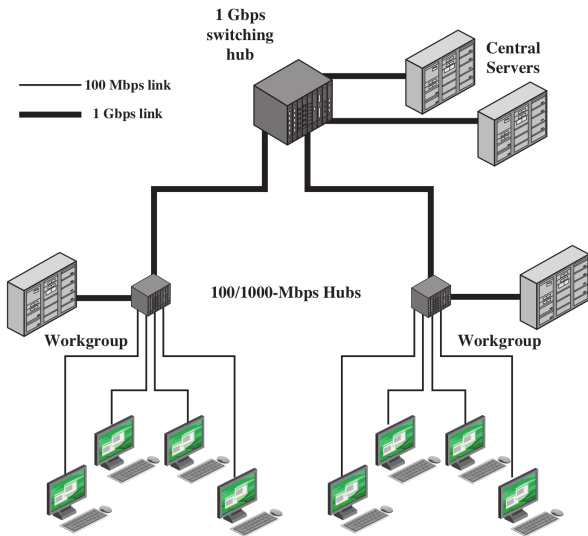

Example 10 Gigabit Ethernet Configuration

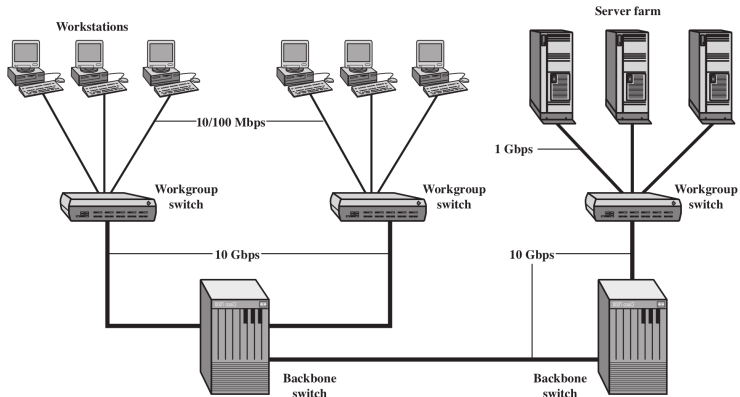

Contents

LAN Design

IEEE 802

Frame & Address

LAN Design Elements

IEEE 802 LANs

IEEE 802.3 MAC Frames and Addresses

MAC Frame Compared to Other Layers

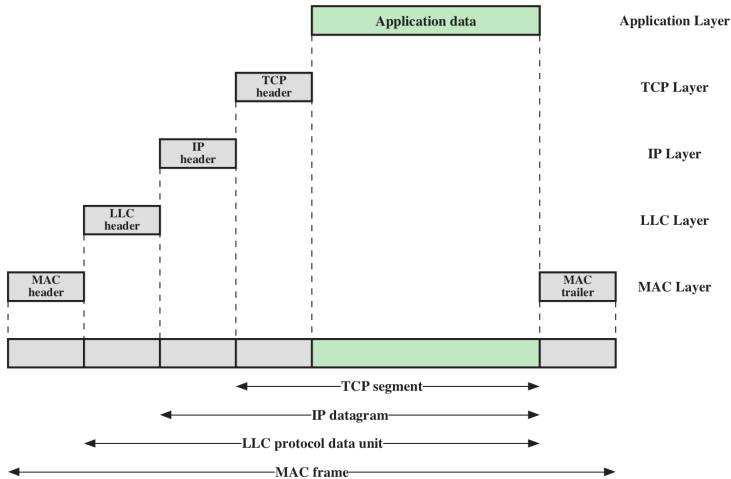

LLC PDU in a Generic MAC Frame Format

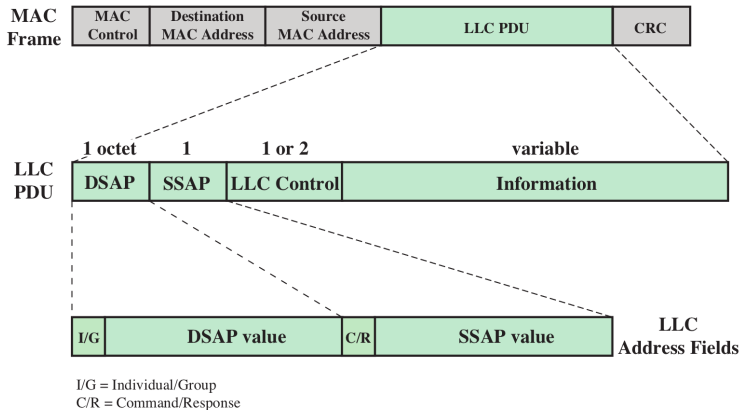

- ▶ LLC traditionally provided link level flow and error control and multiplexing
- ▶ Today, in many IP networks LLC features are not needed; IP datagram encapsulated directly into MAC frame with 2 Byte EtherType field

IEEE 802.3 MAC Frame Format

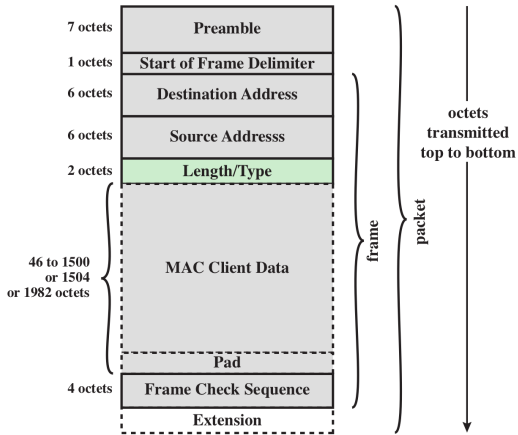

- ▶ Typical maximum data size is 1500 Bytes
- ▶ 1st 8 bytes (preamble, delimiter) sometimes considered part of Physical layer

IEEE 802 Addresses

- ▶ IEEE 802 standards use common IEEE 48-bit address format
- ▶ Globally unique (ideally)
 - ▶ First 24-bits assigned by IEEE to manufacturer
<http://standards.ieee.org/regauth/oui/>
 - ▶ Second 24-bits assigned by manufacturer to device
- ▶ For simplicity, represented as 6×2 digit hexadecimal numbers
- ▶ Common in other standards: Bluetooth, ATM, FDDI, FibreChannel
- ▶ IEEE 64-bit address is new format: Firewire, ZigBee, IPv6

IEEE Addressing Example

Find the 48-bit IEEE address of your computer.