

Key Management and Distribution

CSS322: Security and Cryptography

Sirindhorn International Institute of Technology
Thammasat University

Prepared by Steven Gordon on 31 October 2012
CSS322Y12S2L10, Steve/Courses/2012/s2/css322/lectures/key.tex, r2531

Contents

Key Distribution and Management

Symmetric Key Distribution using Symmetric Encryption

Symmetric Key Distribution using Asymmetric Encryption

Distribution of Public Keys

X.509 Certificates

Key Distribution and Management

- ▶ Symmetric key cryptography: fast implementations, good for encrypting large amounts of data; requires shared secret key
- ▶ Asymmetric (public) key cryptography: inefficient for large data, good for authentication; no need to share a secret
- ▶ How to share symmetric keys?
- ▶ How to distribute public keys?

Contents

Key Distribution and Management

Symmetric Key Distribution using Symmetric Encryption

Symmetric Key Distribution using Asymmetric Encryption

Distribution of Public Keys

X.509 Certificates

Symmetric Key Distribution using Symmetric Encryption

- ▶ Objective: two entities share same secret key
- ▶ Principle: change keys frequently
- ▶ How to exchange a secret key?
 1. A physically delivers key to B
 2. Third party, C, can physically deliver key to A and B
 3. If A and B already have a key, can securely transmit new key to each other, encrypted with old key
 4. If A and B have secure connection with third party C, C can securely send keys to A and B
- ▶ Option 1 and 2: manual delivery; feasible if number of entities is small (link encryption)
- ▶ Option 3: requires initial distribution of key; discovery of initial key releases all subsequent keys
- ▶ Option 4: requires initial distribution of key with C; practical for large-scale systems (end-to-end encryption)

Link Encryption vs End-to-End Encryption

Link Encryption

- ▶ Encrypt data over individual links in network
- ▶ Each link end-point shares a secret key
- ▶ Decrypt/Encrypt at each device in path
- ▶ Requires all links/devices to support encryption

End-to-End Encryption

- ▶ Encrypt data at network end-points (e.g. hosts or applications)
- ▶ Each pair of hosts/applications share a secret key
- ▶ Does not rely on intermediate network devices

How Many Keys Need To Be Exchanged?

Key Management

Key Distribution

Symmetric with
Symmetric

Symmetric with
Asymmetric

Public Keys

X.509

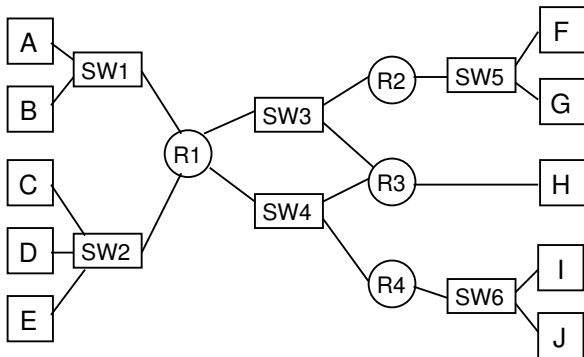

- ▶ Link-level encryption?
- ▶ End-to-end encryption between hosts?
- ▶ End-to-end encryption between applications?

Using a Key Distribution Centre

- ▶ Key Distribution Centre (KDC) is trusted third party
- ▶ Hierarchy of keys used:
 - ▶ Data sent between end-systems encrypted with temporary **session key**
 - ▶ Session keys obtained from KDC over network; encrypted with **master key**
 - ▶ Master keys can be distributed using manual delivery

Use of a Key Hierarchy

Key Management

Key Distribution

Symmetric with
SymmetricSymmetric with
Asymmetric

Public Keys

X.509

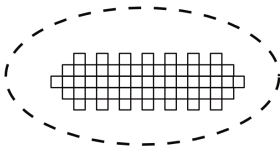
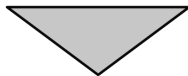
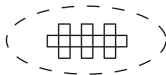
Data**Cryptographic
Protection****Session Keys****Cryptographic
Protection****Master Keys****Non-Cryptographic
Protection**

Key Distribution Scenario

Key Management

Key Distribution

Symmetric with Symmetric

Symmetric with Asymmetric

Public Keys

X.509

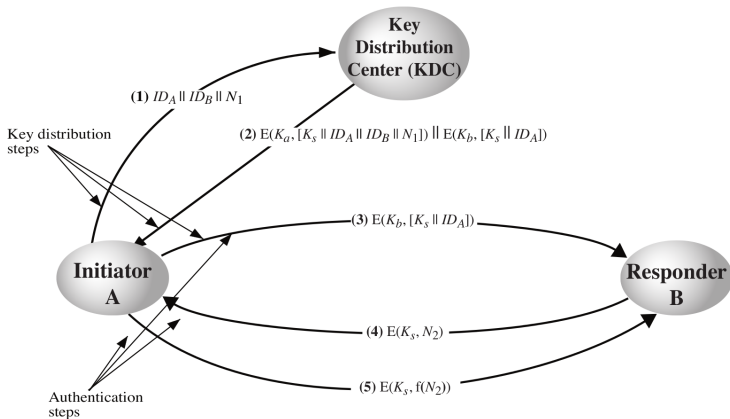

KDC Scenario Notation

- ▶ End-systems: A and B , identified by ID_A and ID_B
- ▶ Master keys: K_a, K_b
- ▶ Session key (between A and B): K_s
- ▶ Nonce values: N_1, N_2
 - ▶ E.g. timestamp, counter, random value
 - ▶ Must be different for each request
 - ▶ Must be difficult for attacker to guess

Practical Considerations

Hierarchical Key Control

- ▶ Use multiple KDCs in a hierarchy
- ▶ E.g. KDC for each LAN (or building); central KDC to exchange keys between hosts in different LANs
- ▶ Reduces effort in key distribution; limits damage if local KDC is compromised

Session Key Lifetime

- ▶ Shorter lifetime is more secure; but increases overhead of exchanges
- ▶ Connection-oriented protocols (e.g. TCP): new session key for each connection
- ▶ Connection-less protocols (e.g. UDP/IP): change after fixed period or certain number of packets sent

Decentralised Key Distribution

Key Management

Key Distribution

Symmetric with
SymmetricSymmetric with
Asymmetric

Public Keys

X.509

- ▶ Alternative that doesn't rely on KDC
- ▶ Each end-system must manually exchange $n - 1$ master keys (K_m) with others

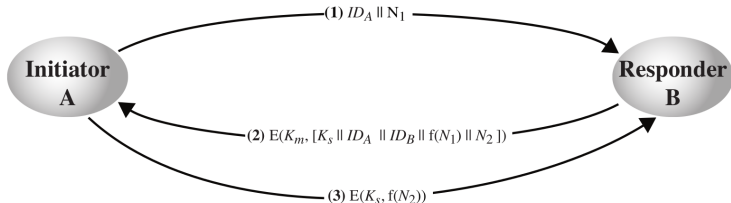

Contents

Key Distribution and Management

Symmetric Key Distribution using Symmetric Encryption

Symmetric Key Distribution using Asymmetric Encryption

Distribution of Public Keys

X.509 Certificates

Symmetric Key Distribution using Asymmetric Encryption

- ▶ Asymmetric encryption generally too slow for encrypting large amount of data
- ▶ Common application of asymmetric encryption is exchanging secret keys
- ▶ Three examples:
 1. Simple Secret Key Distribution
 2. Secret Key Distribution with Confidentiality and Authentication
 3. Hybrid Scheme: Public-Key Distribution of KDC Master Keys

Simple Secret Key Distribution

- ▶ Simple: no keys prior to or after communication
- ▶ Provides confidentiality for session key
- ▶ Subject to **man-in-the-middle attack**
- ▶ Only useful if attacker cannot modify/insert messages

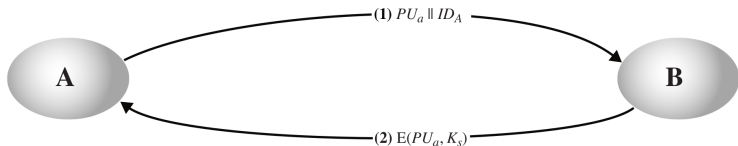

Man-in-the-Middle Attack

Key Management

Key Distribution

Symmetric with
Symmetric

**Symmetric with
Asymmetric**

Public Keys

X.509

Secret Key Distribution with Confidentiality and Authentication

- ▶ Provides both confidentiality and authentication in exchange of secret key

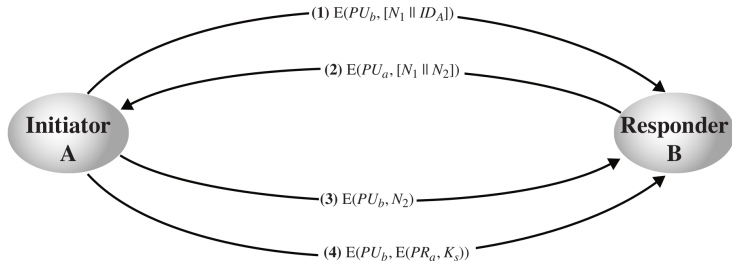

Hybrid Scheme: Public-Key Distribution of KDC Master Keys

- ▶ Use public-key distribution of secret keys when exchanging master keys between end-systems and KDC
- ▶ Efficient method of delivering master keys (rather than manual delivery)
- ▶ Useful for large networks, widely distributed set of users with single KDC

Contents

Key Distribution and Management

Symmetric Key Distribution using Symmetric Encryption

Symmetric Key Distribution using Asymmetric Encryption

Distribution of Public Keys

X.509 Certificates

Distribution of Public Keys

- ▶ By design, public keys are made public
- ▶ Issue: how to ensure public key of A actually belongs to A (and not someone pretending to be A)
- ▶ Four approaches for distributing public keys
 1. Public announcement
 2. Publicly available directory
 3. Public-key authority
 4. Public-key certificates

Public Announcements

- ▶ Make public key available in open forum: newspaper, email signature, website, conference, . . .
- ▶ Problem: anyone can announce a key pretending to be another user

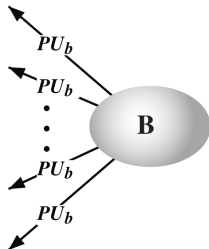
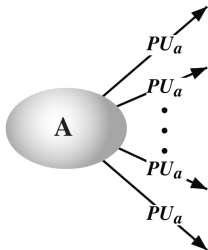

Publicly Available Directory

- ▶ All users publish keys in central directory
- ▶ Users must provide identification when publishing key
- ▶ Users can access directory electronically
- ▶ Weakness: directory must be secure

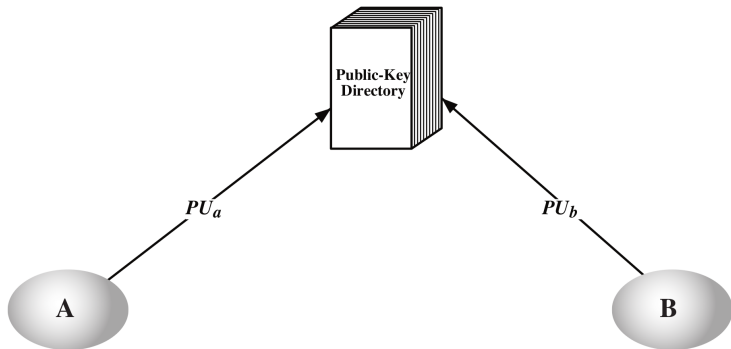

Public-Key Authority

Key Management

Key Distribution

Symmetric with
SymmetricSymmetric with
Asymmetric

Public Keys

X.509

- ▶ Specific instance of using publicly available directory
- ▶ Assume each user has already security published public-key at authority; each user knows authorities public key

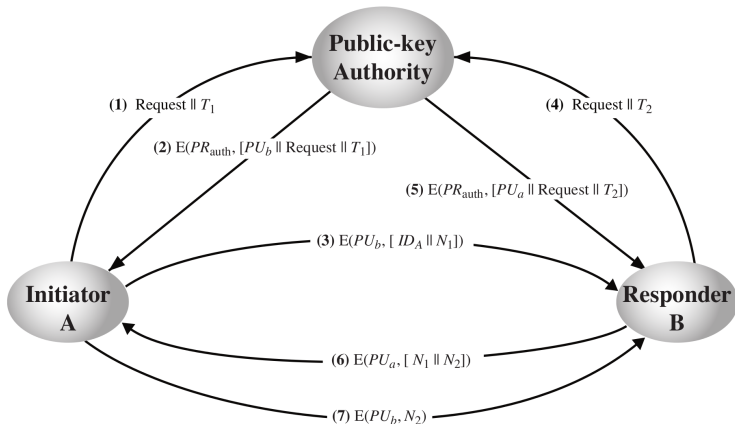

Public-Key Authority

- ▶ First 5 messages are for key exchange; last 2 are authentication of users
- ▶ Although 7 messages, public keys obtained from authority can be cached
- ▶ Problem: authority can be bottleneck
- ▶ Alternative: public-key certificates

Public-Key Certificates

Key Management

Key Distribution

Symmetric with
SymmetricSymmetric with
Asymmetric

Public Keys

X.509

- Assume public keys sent to CA can be authenticated by CA; each user has certificate of CA

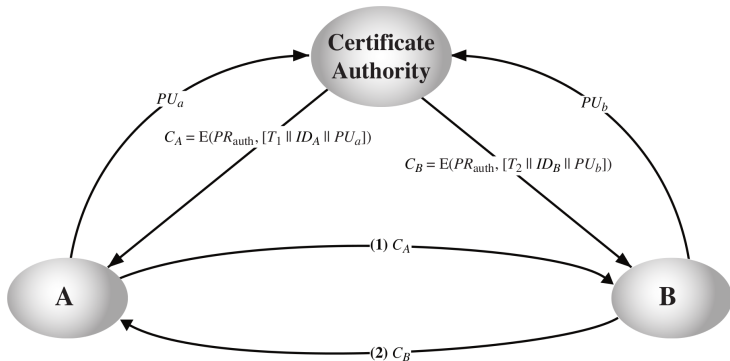

Public Key Certificates

- ▶ A certificate is the ID and public-key of a user signed by CA

$$C_A = E(PR_{auth}, [T || ID_A || PU_a])$$

- ▶ Timestamp T validates currency of certificate (expiration date)
- ▶ Common format for certificates is X.509 standard (by ITU)
 - ▶ S/MIME (secure email)
 - ▶ IP security (network layer security)
 - ▶ SSL/TLS (transport layer security)
 - ▶ SET (e-commerce)

Contents

Key Distribution and Management

Symmetric Key Distribution using Symmetric Encryption

Symmetric Key Distribution using Asymmetric Encryption

Distribution of Public Keys

X.509 Certificates

X.509 Certificates

- ▶ Each user has a certificate, although it is created by the Certificate Authority (CA)
- ▶ Certificates are stored in a public directory
- ▶ Certificate format includes:
 - ▶ Version of X.509 certificate
 - ▶ Signature algorithm
 - ▶ CA's name and unique identifier
 - ▶ Period of validity
 - ▶ User's name and unique identifier
 - ▶ User's public key information
 - ▶ Signature

Public-Key Certificate Use

Key Management

Key Distribution

Symmetric with
SymmetricSymmetric with
Asymmetric

Public Keys

X.509

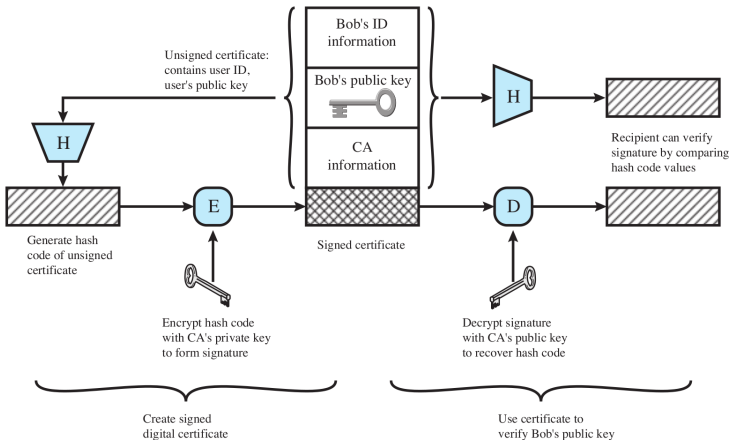

X.509 Formats

Key Management

Key Distribution

Symmetric with
SymmetricSymmetric with
Asymmetric

Public Keys

X.509

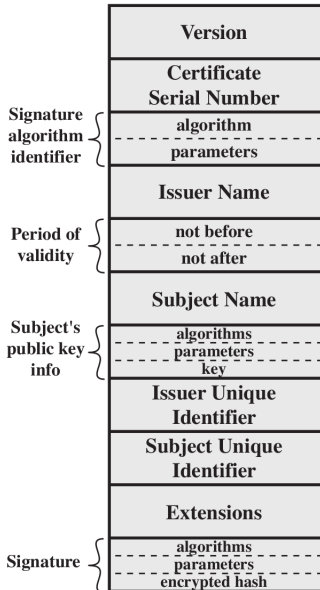

Certificate Revocation List

Key Management

Key Distribution

Symmetric with
SymmetricSymmetric with
Asymmetric

Public Keys

X.509

- ▶ Certificates may be revoked before expiry
- ▶ CA signs a CRL, which is stored in public directory

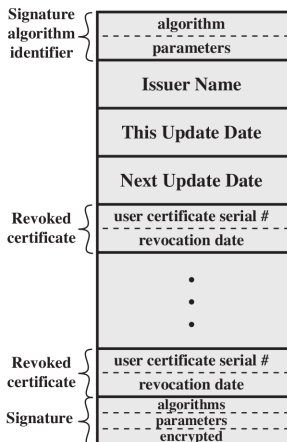

Multiple Certificate Authorities

Key Management

Key Distribution

Symmetric with
SymmetricSymmetric with
Asymmetric

Public Keys

X.509

- ▶ Multiple CA's can be arranged in hierarchy
- ▶ Notation: $Y \ll X \gg$ certificate of X issued by CA Y

