

Public Key Cryptography

CSS322: Security and Cryptography

Sirindhorn International Institute of Technology
Thammasat University

Prepared by Steven Gordon on 29 December 2011
CSS322Y11S2L07, Steve/Courses/2011/S2/CSS322/Lectures/rsa.tex, r2070

Contents

Principles of Public-Key Cryptosystems

The RSA Algorithm

Diffie-Hellman Key Exchange

Other Public-Key Cryptosystems

Birth of Public-Key Cryptosystems

- ▶ Beginning to 1960's: permutations and substitutions (Caesar, rotor machines, DES, ...)
- ▶ 1960's: NSA secretly discovered public-key cryptography
- ▶ 1970: first known (secret) report on public-key cryptography by CESH, UK
- ▶ 1976: Diffie and Hellman public introduction to public-key cryptography
 - ▶ Avoid reliance on third-parties for key distribution
 - ▶ Allow digital signatures

Principles of Public-Key Cryptosystems

- ▶ Symmetric algorithms used same secret key for encryption and decryption
- ▶ Asymmetric algorithms in public-key cryptography use one key for encryption and different but related key for decryption
- ▶ Characteristics of asymmetric algorithms:
 - ▶ Require: Computationally infeasible to determine decryption key given only algorithm and encryption key
 - ▶ Optional: Either of two related keys can be used for encryption, with other used for decryption

Public and Private Keys

Public Key

- ▶ For secrecy: used in encryption
- ▶ For authentication: used in decryption
- ▶ Available to anyone

Private Key

- ▶ For secrecy: used in decryption
- ▶ For authentication: used in encryption
- ▶ Secret, known only by owner

Public-Private Key Pair

- ▶ User A has pair of related keys, public and private:
(PU_a, PR_a)

Encryption with Public Key

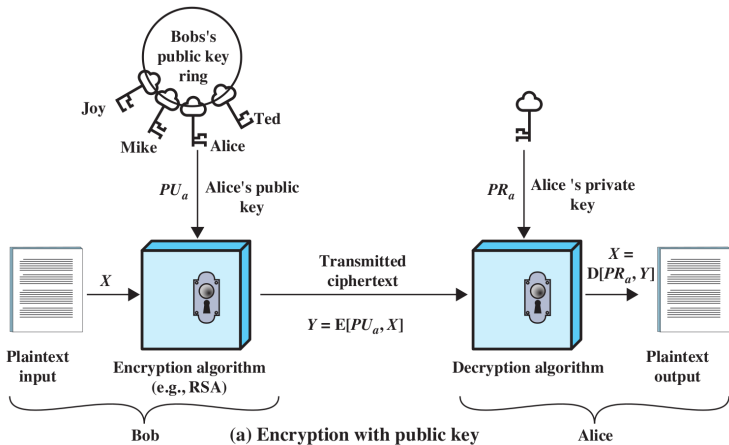

Encryption with Private Key

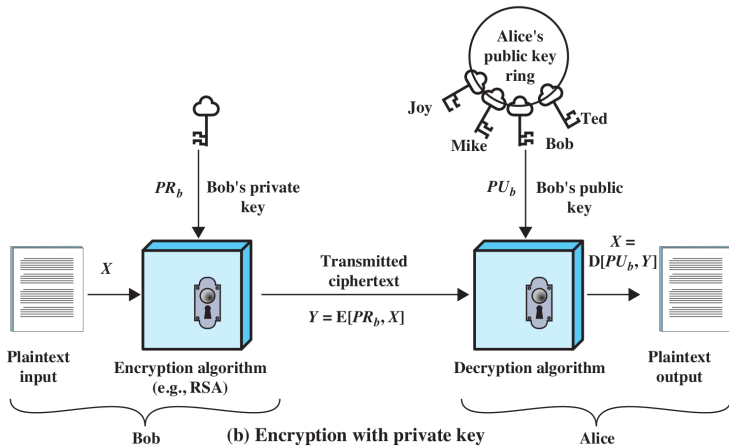

Conventional vs Public-Key Encryption

Conventional Encryption	Public-Key Encryption
<p data-bbox="282 215 460 236"><i>Needed to Work:</i></p> <ol data-bbox="312 277 776 422" style="list-style-type: none"> <li data-bbox="312 277 776 332">1. The same algorithm with the same key is used for encryption and decryption. <li data-bbox="312 365 776 422">2. The sender and receiver must share the algorithm and the key. <p data-bbox="282 456 499 477"><i>Needed for Security:</i></p> <ol data-bbox="312 519 755 778" style="list-style-type: none"> <li data-bbox="312 519 755 539">1. The key must be kept secret. <li data-bbox="312 576 755 658">2. It must be impossible or at least impractical to decipher a message if no other information is available. <li data-bbox="312 695 755 778">3. Knowledge of the algorithm plus samples of ciphertext must be insufficient to determine the key. 	<p data-bbox="799 215 978 236"><i>Needed to Work:</i></p> <ol data-bbox="830 277 1293 477" style="list-style-type: none"> <li data-bbox="830 277 1293 360">1. One algorithm is used for encryption and decryption with a pair of keys, one for encryption and one for decryption. <li data-bbox="830 396 1293 477">2. The sender and receiver must each have one of the matched pair of keys (not the same one). <p data-bbox="799 513 1016 534"><i>Needed for Security:</i></p> <ol data-bbox="830 576 1293 871" style="list-style-type: none"> <li data-bbox="830 576 1293 596">1. One of the two keys must be kept secret. <li data-bbox="830 632 1293 715">2. It must be impossible or at least impractical to decipher a message if no other information is available. <li data-bbox="830 752 1293 871">3. Knowledge of the algorithm plus one of the keys plus samples of ciphertext must be insufficient to determine the other key.

Secrecy in a Public Key Cryptosystem

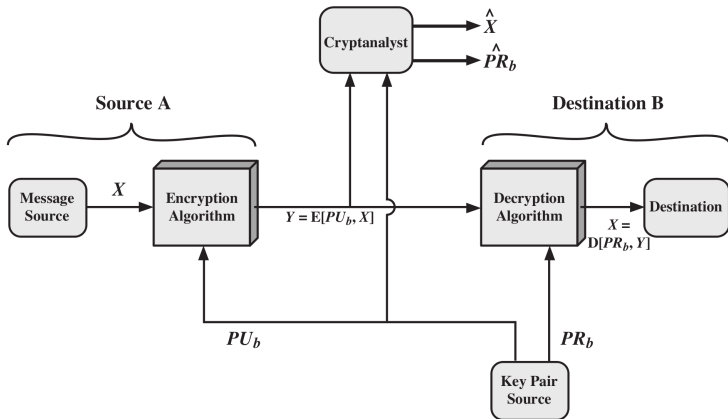

Authentication in a Public Key Cryptosystem

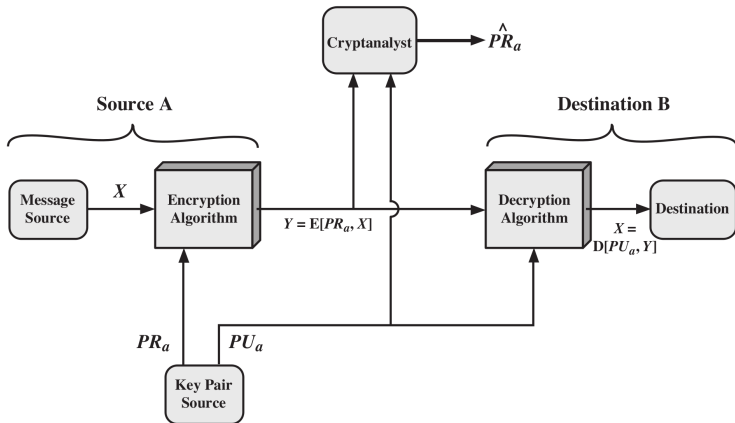

Secrecy and Authentication in a Public Key Cryptosystem

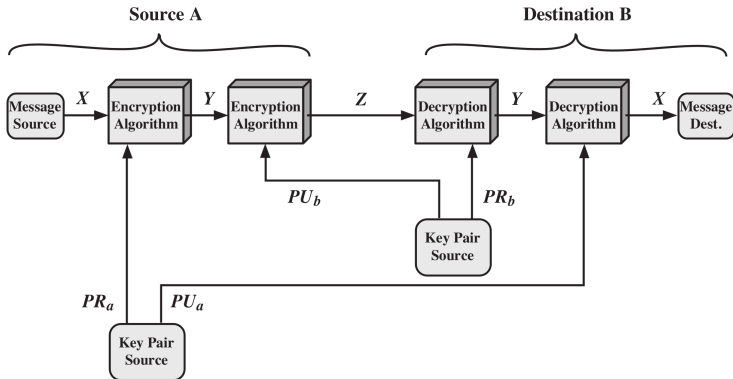

Applications of Public Key Cryptosystems

- ▶ Secrecy, encryption/decryption of messages
- ▶ Digital signature, *sign* message with private key
- ▶ Key exchange, share secret session keys

Algorithm	Encryption/Decryption	Digital Signature	Key Exchange
RSA	Yes	Yes	Yes
Elliptic Curve	Yes	Yes	Yes
Diffie-Hellman	No	No	Yes
DSS	No	Yes	No

Requirements of Public-Key Cryptography

1. Computationally easy for B to generate pair (PU_b, PR_b)
2. Computationally easy for A , knowing PU_b and message M , to generate ciphertext:

$$C = E(PU_b, M)$$

3. Computationally easy for B to decrypt ciphertext using PR_b :

$$M = D(PR_b, C) = D[PR_b, E(PU_b, M)]$$

4. Computationally infeasible for attacker, knowing PU_b and C , to determine PR_b
5. Computationally infeasible for attacker, knowing PU_b and C , to determine M
6. (Optional) Two keys can be applied in either order:

$$M = D[PU_b, E(PR_b, M)] = D[PR_b, E(PU_b, M)]$$

Requirements of Public-Key Cryptography

6 requirements lead to need for **trap-door one-way function**

- ▶ Every function value has unique inverse
- ▶ Calculation of function is easy
- ▶ Calculation of inverse is infeasible, unless certain information is known

$$Y = f_k(X) \quad \text{easy, if } k \text{ and } Y \text{ are known}$$

$$X = f_k^{-1}(Y) \quad \text{easy, if } k \text{ and } Y \text{ are known}$$

$$X = f_k^{-1}(Y) \quad \text{infeasible, if } Y \text{ is known but } k \text{ is not}$$

- ▶ What is easy? What is infeasible?
 - ▶ Computational complexity of algorithm gives an indication
 - ▶ Easy if can be solved in polynomial time as function of input

Public-Key Cryptanalysis

Brute Force Attacks

- ▶ Use large key to avoid brute force attacks
- ▶ Public key algorithms less efficient with larger keys
- ▶ Public-key cryptography mainly used for key management and signatures

Compute Private Key from Public Key

- ▶ No known feasible methods using standard computing

Probable-Message Attack

- ▶ Encrypt all possible M' using PU_b —for the C' that matches C , attacker knows M
- ▶ Only feasible if M is short
- ▶ Solution for short messages: append random bits to make it longer

Contents

Principles of Public-Key Cryptosystems

The RSA Algorithm

Diffie-Hellman Key Exchange

Other Public-Key Cryptosystems

RSA

Public Key Crypto

Principles

RSA

Diffie-Hellman

Others

- ▶ Ron Rivest, Adi Shamir and Len Adleman
- ▶ Created in 1978; RSA Security sells related products
- ▶ Most widely used public-key algorithm
- ▶ Block cipher: plaintext and ciphertext are integers

The RSA Algorithm

- ▶ Plaintext encrypted in blocks, each block binary value less than n
- ▶ In practice, block size i bits where $2^i < n \leq 2^{i+1}$; n is 1024 bits
- ▶ Encryption of plaintext M :

$$C = M^e \bmod n$$

- ▶ Decryption of ciphertext C :

$$\begin{aligned} M &= C^d \bmod n \\ &= (M^e)^d \bmod n = M^{ed} \bmod n \end{aligned}$$

- ▶ Sender A and receiver B know n ; Sender A knows e ; Receiver B knows d
- ▶ $PU_b = \{e, n\}$, $PR_b = \{d, n\}$

Requirements of the RSA Algorithm

1. Possible to find values of e , d , n such that $M^{ed} \bmod n = M$ for all $M < n$
2. Easy to calculate $M^e \bmod n$ and $C^d \bmod n$ for all values of $M < n$
3. Infeasible to determine d given e and n
 - ▶ Requirement 1 met if e and d are relatively prime
 - ▶ Choose primes p and q , and calculate:

$$n = pq$$

$$1 < e < \phi(n)$$

$$ed \equiv 1 \pmod{\phi(n)} \text{ or } d \equiv e^{-1} \pmod{\phi(n)}$$

- ▶ n and e are public; p , q and d are private

The RSA Algorithm

Public Key Crypto

Principles

RSA

Diffie-Hellman

Others

Key Generation by Alice

Select p, q	p and q both prime, $p \neq q$
Calculate $n = p \times q$	
Calculate $\phi(n) = (p - 1)(q - 1)$	
Select integer e	$\gcd(\phi(n), e) = 1; 1 < e < \phi(n)$
Calculate d	$d \equiv e^{-1} \pmod{\phi(n)}$
Public key	$PU = \{e, n\}$
Private key	$PR = \{d, n\}$

Encryption by Bob with Alice's Public Key

Plaintext:	$M < n$
Ciphertext:	$C = M^e \pmod n$

Decryption by Alice with Alice's Private Key

Ciphertext:	C
Plaintext:	$M = C^d \pmod n$

Example of RSA Algorithm

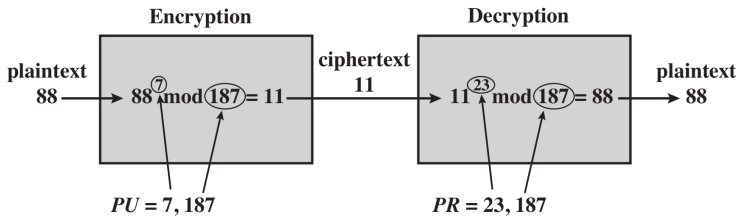

RSA Processing of Multiple Blocks

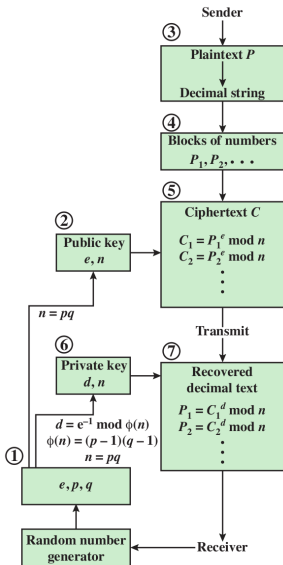

Example of RSA Processing of Multiple Blocks

Principles

RSA

Diffie-Hellman

Others

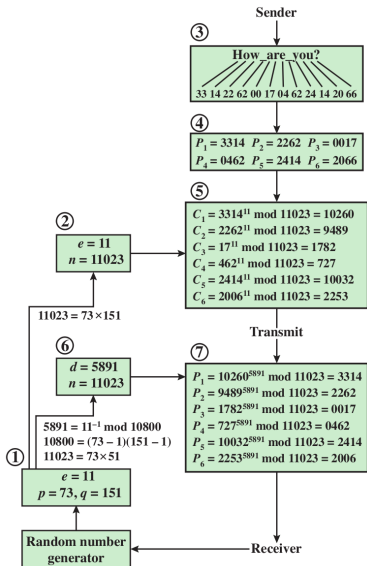

Computational Efficiency of RSA

- ▶ Encryption and decryption require exponentiation
 - ▶ Very large numbers; using properties of modular arithmetic makes it easier:

$$[(a \bmod n) \times (b \bmod n)] \bmod n = (a \times b) \bmod n$$

- ▶ Choosing e
 - ▶ Values such as 3, 17 and 65537 are popular: make exponentiation faster
 - ▶ Small e vulnerable to attack: add random padding to each M
- ▶ Choosing d
 - ▶ Small d vulnerable to attack
 - ▶ Decryption using large d made faster using Chinese Remainder Theorem and Fermat's Theorem
- ▶ Choosing p and q
 - ▶ p and q must be very large primes
 - ▶ Choose random odd number and test if its prime (probabilistic test)

Security of RSA

- ▶ Brute-Force attack: choose large d (but makes algorithm slower)
- ▶ Mathematical attacks:
 1. Factor n into its two prime factors
 2. Determine $\phi(n)$ directly, without determining p or q
 3. Determine d directly, without determining $\phi(n)$
 - ▶ Factoring n is considered fastest approach; hence used as measure of RSA security
- ▶ Timing attacks: practical, but countermeasures easy to add (e.g. random delay). 2 to 10% performance penalty
- ▶ Chosen ciphertext attack: countermeasure is to use padding (Optimal Asymmetric Encryption Padding)

MIPS-Years Needed To Factor

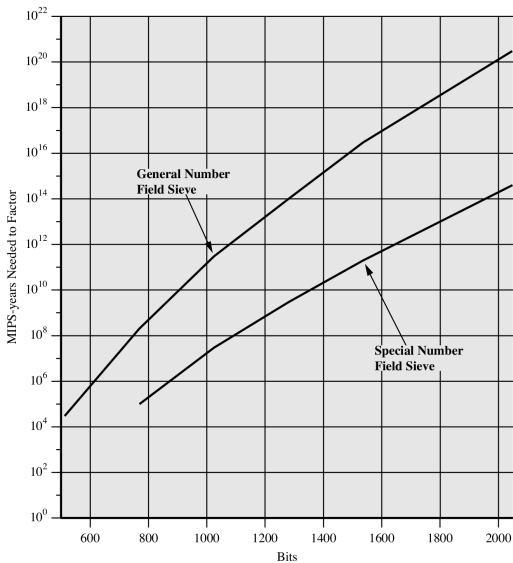

Progress in Factorization

Principles

RSA

Diffie-Hellman

Others

Number of Decimal Digits	Approximate Number of Bits	Date Achieved	MIPS-Years	Algorithm
100	332	April 1991	7	Quadratic sieve
110	365	April 1992	75	Quadratic sieve
120	398	June 1993	830	Quadratic sieve
129	428	April 1994	5000	Quadratic sieve
130	431	April 1996	1000	Generalized number field sieve
140	465	February 1999	2000	Generalized number field sieve
155	512	August 1999	8000	Generalized number field sieve
160	530	April 2003	—	Lattice sieve
174	576	December 2003	—	Lattice sieve
200	663	May 2005	—	Lattice sieve

See <http://www.rsa.com/rsalabs/node.asp?id=2092> for update. RSA-768 has been solved.

Contents

Principles of Public-Key Cryptosystems

The RSA Algorithm

Diffie-Hellman Key Exchange

Other Public-Key Cryptosystems

Diffie-Hellman Key Exchange

- ▶ Diffie and Hellman proposed public key cryptosystem in 1976
- ▶ Algorithm for exchanging secret key (not for secrecy of data)
- ▶ Based on discrete logarithms
- ▶ Easy to calculate exponentials modulo a prime
- ▶ Infeasible to calculate inverse, i.e. discrete logarithm

Diffie-Hellman Key Exchange Algorithm

Global Public Elements

q	prime number
α	$\alpha < q$ and α a primitive root of q

User A Key Generation

Select private X_A	$X_A < q$
Calculate public Y_A	$Y_A = \alpha^{X_A} \bmod q$

User B Key Generation

Select private X_B	$X_B < q$
Calculate public Y_B	$Y_B = \alpha^{X_B} \bmod q$

Calculation of Secret Key by User A

$$K = (Y_B)^{X_A} \bmod q$$

Calculation of Secret Key by User B

$$K = (Y_A)^{X_B} \bmod q$$

Diffie-Hellman Key Exchange

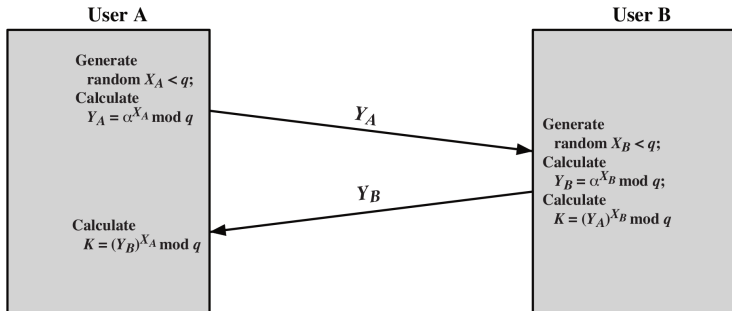

Security of Diffie-Hellman Key Exchange

- ▶ Insecure against man-in-the-middle-attack
- ▶ Countermeasure is to use digital signatures and public-key certificates

Contents

Principles of Public-Key Cryptosystems

The RSA Algorithm

Diffie-Hellman Key Exchange

Other Public-Key Cryptosystems

Other Public-Key Cryptosystems

ElGamal Cryptosystem

- ▶ Similar concepts to Diffie-Hellman
- ▶ Used in Digital Signature Standard and secure email

Elliptic Curve Cryptography

- ▶ Uses elliptic curve arithmetic (instead of modular arithmetic in RSA)
- ▶ Equivalent security to RSA with smaller keys (better performance)
- ▶ Used for key exchange and digital signatures